

APPLICATIONS

- Uninterruptible Power Supplies (UPS)
- Electric Power Systems (EPS)
- Emergency backup power supplies
- Electronic apparatus and equipment
- Communication power supplies
- DC power supplies
- Auto control system

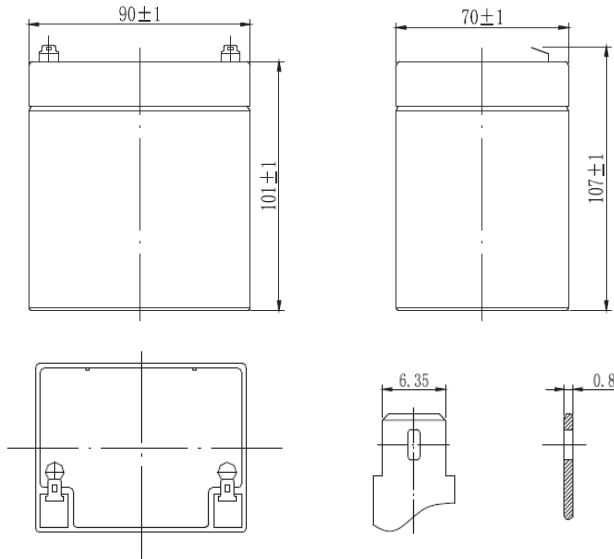

SPECIFICATIONS

Nominal Voltage	12 V	
Number of cells	6	
Design Floating Life (20°C)	10 years	
Dimensions	Length	90 mm
	Width	70 mm
	Height	101 mm
	Total Height	107 mm
Weight	1.55 kg	
Nominal Capacity (25°C)	20 hours rate (1.75)	5.00 Ah
	10 hours rate (1.75)	4.70 Ah
	5 hours rate (1.75)	4.25 Ah
	1 hour rate (1.65)	3.23 Ah
Internal Resistance (fully charged, 25°C)	25 mOhm	
Self Discharge	approx. 3% per month at 25°C	
Nominal Operating Temperature	25°C	
Operating Temperature range	Discharge	-15°C to 45°C
	Charge	0°C to 40°C
	Storage	-15°C to 40°C
Float Charging Voltage	2.27 to 2.30 V/cell at 25°C	
Temperature compensation	-18mV/°C	
Maximum charging current	1.50 A	
Maximum discharge current (25°C)	50 A (5 sec.)	
Short Circuit Current (25°C)	75 A	

PERFORMANCE DATA

Discharge Constant Current at 25°C (Amperes)

End Voltage (V/cell)	5min	10min	15min	30min	1h	2h	3h	4h	5h	8h	10h	20h
1.60V	18.9	12.2	9.59	5.49	3.27	1.81	1.32	1.05	0.91	0.57	0.50	0.26
1.65V	18.4	11.5	9.36	5.35	3.23	1.80	1.31	1.04	0.89	0.57	0.49	0.26
1.70V	17.4	11.1	9.04	5.08	3.13	1.78	1.30	1.04	0.87	0.56	0.48	0.26
1.75V	16.5	10.8	8.73	4.95	3.05	1.75	1.29	1.03	0.85	0.55	0.47	0.25
1.80V	15.9	10.3	8.25	4.76	2.96	1.71	1.25	1.00	0.83	0.54	0.46	0.25

Discharge Constant Power at 25°C (Watts/Cell)

End Voltage (V/cell)	5min	10min	15min	30min	1h	2h	3h	4h	5h	8h	10h	20h
1.60V	35.1	22.2	17.2	10.1	6.29	3.48	2.55	2.05	1.77	1.16	0.97	0.53
1.65V	34.2	21.6	17.0	9.87	6.14	3.46	2.55	2.05	1.75	1.14	0.96	0.53
1.70V	32.3	20.5	17.0	9.64	6.01	3.42	2.54	2.03	1.73	1.13	0.96	0.52
1.75V	31.3	19.5	16.4	9.41	5.90	3.37	2.52	2.01	1.72	1.12	0.95	0.52
1.80V	29.6	18.4	15.5	9.04	5.62	3.29	2.44	1.96	1.67	1.09	0.93	0.51

Note: The above characteristics data can be obtained within three charge/discharge cycles.

Temperature Effects on Float Life

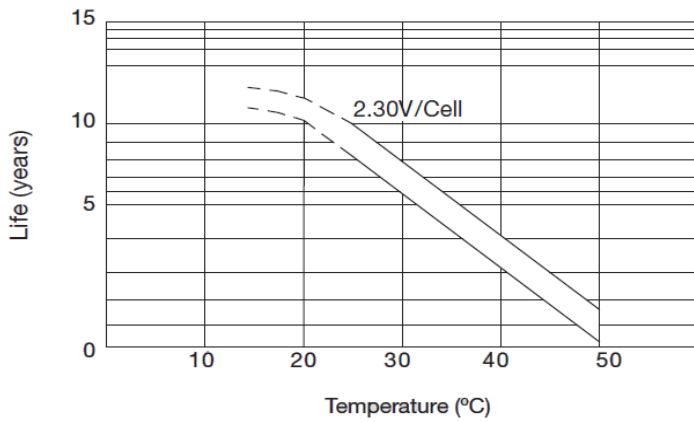

Self Discharge Characteristics

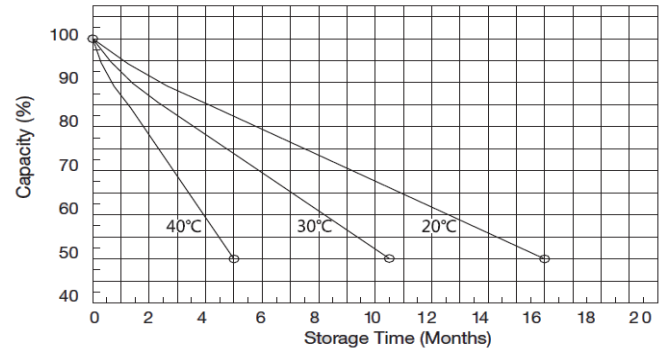

Discharge Characteristics (25°C)

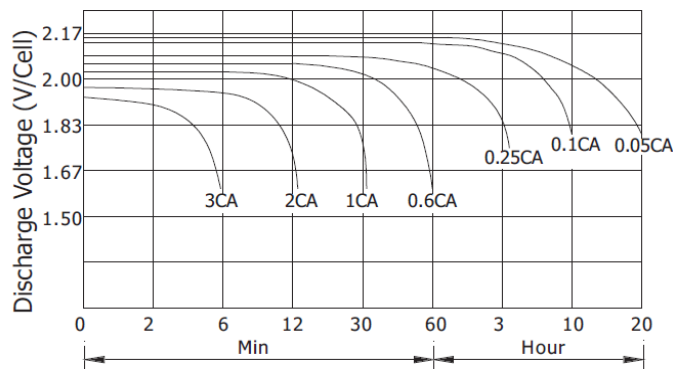

Charging Characteristics (25°C)

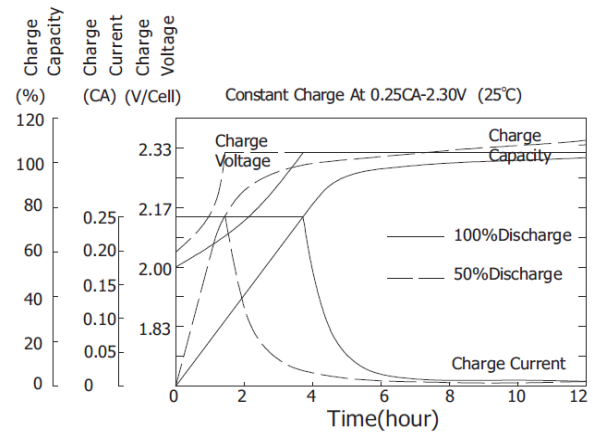

Cycle Service Life in Relation to Depth of Discharge

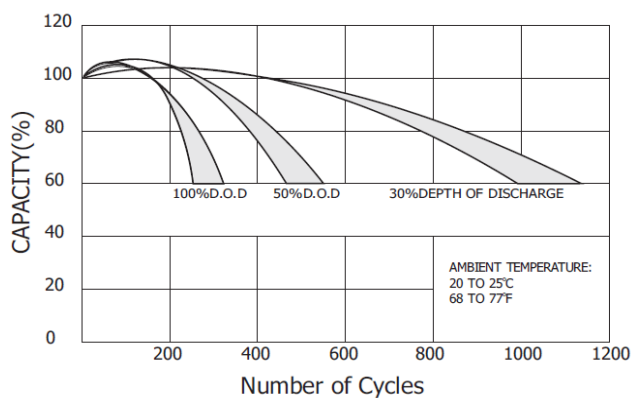

Relationship Between OCV and Residual Capacity (25°C)

